

A = To Water Pickup  
 B = To Exhaust Manifold

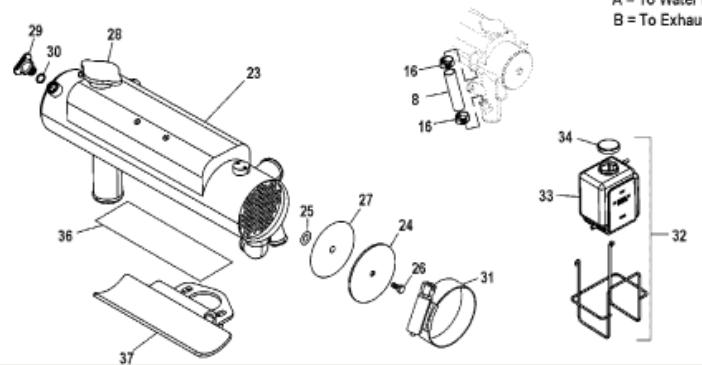

1358

Parts List

Ref	Class	Part	Description	Qty	Comment	Footnote
1	32	863489	HOSE, Transmission Cooler To Che	1		1
2	21	864206A	CHECK VALVE ASSEMBLY	1		1
3	32	864480	HOSE, Check Valve To Tee Fitting	1		1
4	32	863887	HOSE, Intake Bypass To Circulati	1		1
5	32	863793	HOSE, Distribution Fitting To Heat	1		1
6	22	864496	FITTING, Distribution	1		1
7	32	863490	HOSE, Distribution Fitting To Accur	1		1
8	32	42850 69	HOSE, (44.00 Inches Bulk) (Cut To	1		
9	22	862993	FITTING, Drain	3		
10	32	863670	HOSE, Fuel Cooler To Accumulator	1		1
11	32	863885	HOSE, Heat Exchanger To Thermc	1		1
12	32	863886	HOSE, Heat Exchanger To Thermc	1		1
13	32	862125	HOSE, Heat Exchanger To Exhaus	1	(Starboard)	1
14	32	860421	HOSE, Heat Exchanger To Exhaus	1	(Port)	1
15	32	864478	HOSE, T Fitting To Trans Cooler, S	1		
16	54	815504212	CLAMP, Worm Gear, Hose	1		
17	54	815504216	CLAMP, Worm Gear, Hose	1		
18	54	815504222	CLAMP, Worm Gear, Hose	1		
19	54	815504228	CLAMP, Worm Gear, Hose	1		
20	54	815504232	CLAMP, Worm Gear, Hose	1		
21	32	861059	HOSE, Heat Exchanger To Circulat	1		
22	54	815504220	CLAMP, Worm Gear, Hose	1		
23		863709A	HEAT EXCHANGER, Closed Coolir	1		1
24		814875	COVER, Heat Exchanger End	2		
25	27	803644	GASKET, End Cover	2		
26	10	814877	BOLT	2		
27	25	814878	O-RING, Special	2		
28	36	814879	CAP, Pressure	1		
29	22	806608A	PLUG KIT, Blue	1		
30	25	32509	O-RING, (.489 x .070)	1		
31	54	815504388	CLAMP, Worm Gear, Heat Exchang	1		
32		71587A10	COOLANT RECOVERY KIT, Coola	1		
33		71587A11	BOTTLE, Coolant Recovery Kit	1		
34		72058	CAP, Coolant Recovery Bottle	1		
35	32	17435 79	HOSE, (96.00 Inches Bulk), Sea W	1		
36		18431	PAD, Heat Exchanger	1		
37		863680A	BRACKET, Cooler	1		
38	32	864620	HOSE, Tee Fitting To Fuel Cooler	1		
39	32	864477	HOSE, Sea Pump To Tee Fitting	1		
NS	19	807992	COVER, Hose Clamp End	3	A/R	